

Fai la cosa giusta!

Numero di giocatori: 2 gruppi di 4 persone ed un moderatore.

Regole del gioco: Ogni squadra sceglie la carta che rappresenta il suo personaggio. A ogni turno ciascun giocatore prende una carta e la posiziona su una delle 4 tavole colorate (rossa, arancione, gialla o verde) in accordo con i concetti Muovi - Proteggi - Assicura - Adegua, dando una motivazione al moderatore per la scelta. Il moderatore può approvare o rifiutare la mossa: in quest'ultimo caso il giocatore può argomentare con il moderatore e discutere la propria scelta con gli altri giocatori. Se il rifiuto è confermato, la carta viene rimessa nel mazzo. Il giocatore deve passare e aspettare il turno successivo per giocare. Il gruppo che posiziona il maggior numero di carte corrette sul tavolo vince.

I terremoti non possono essere previsti ma i danni ad essi associati possono essere ridotti di molto. Infatti, in qualsiasi zona soggetta a terremoti si è esposti a infortuni, danni e conseguenze economiche a lungo termine. È necessario prendere provvedimenti per ridurre la vulnerabilità nella propria casa.

Questo gioco è basato su una Guida Pratica che mostra semplici azioni utili a rendere la propria casa più sicura.

Autori: G. Musacchio, S. Solarino, E. Eva

Con i contributi di: M. A. Ferreira, C. S. Oliveira, M. Lopes, M. Vicente

Illustrazioni: H. O'Neill

knowriskproject.com

**Fai la
cosa
giusta!**



**Fai la
cosa
giusta!**



**Fai la
cosa
giusta!**



**Fai la
cosa
giusta!**



**Fai la
cosa
giusta!**



**Fai la
cosa
giusta!**



**Fai la
cosa
giusta!**



**Fai la
cosa
giusta!**



**Fai la
cosa
giusta!**



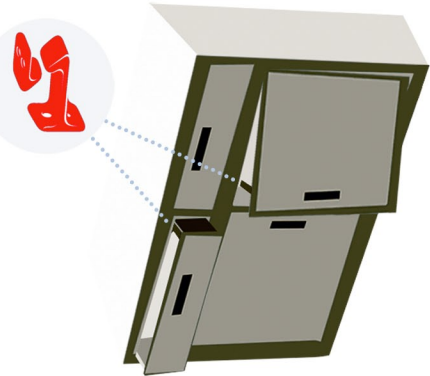
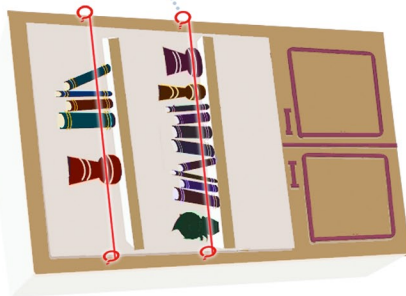
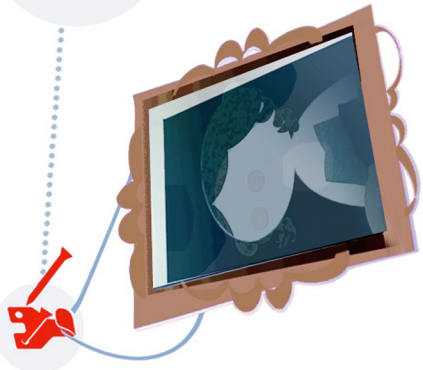
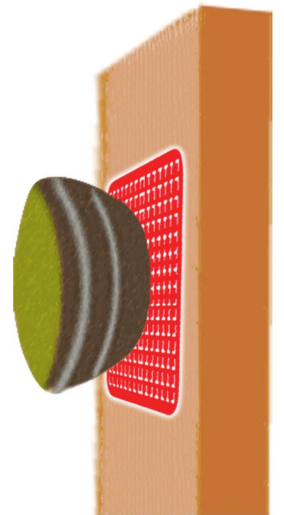
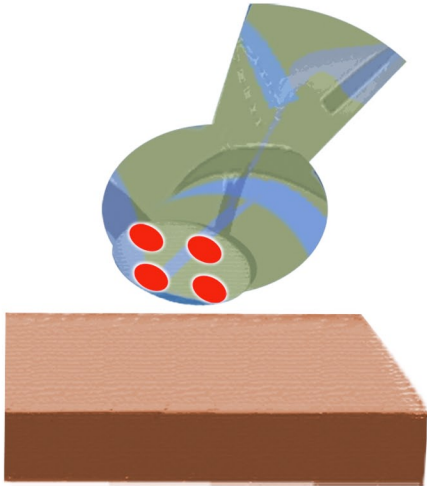
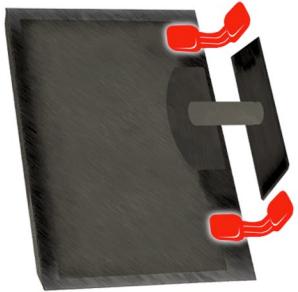
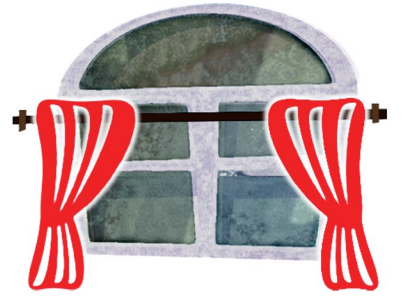
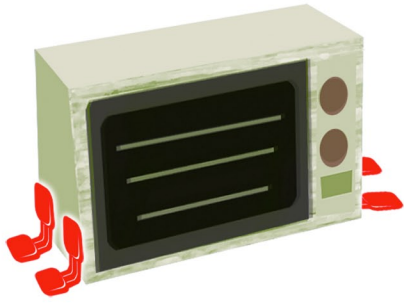

**Fai la
cosa
giusta!**



**Fai la
cosa
giusta!**



**Fai la
cosa
giusta!**



**Fai la
cosa
giusta!**



**Fai la
cosa
giusta!**



**Fai la
cosa
giusta!**



**Fai la
cosa
giusta!**



**Fai la
cosa
giusta!**



**Fai la
cosa
giusta!**



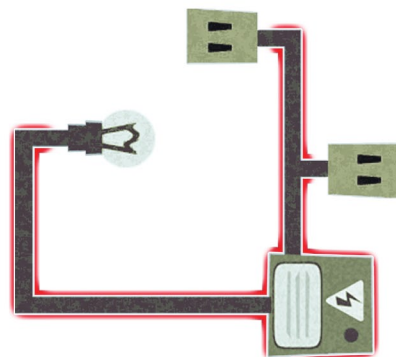
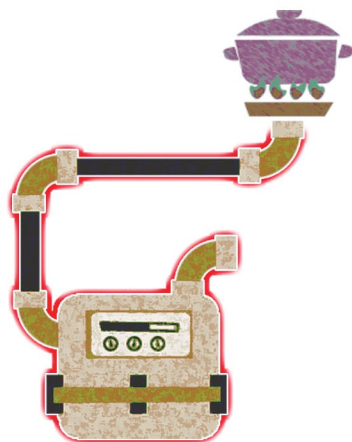
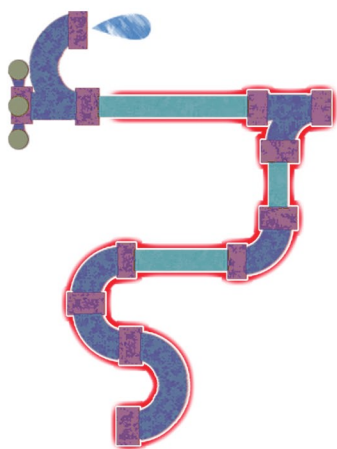
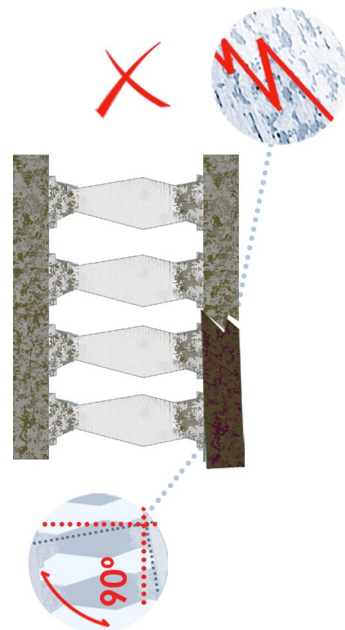
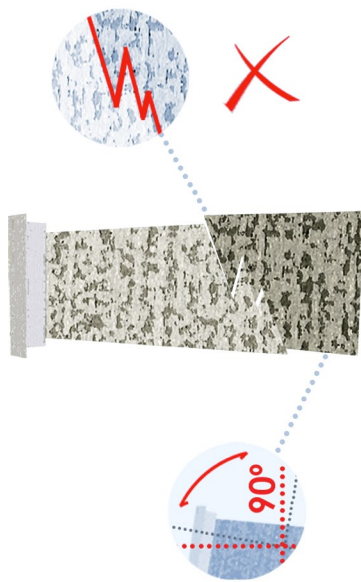
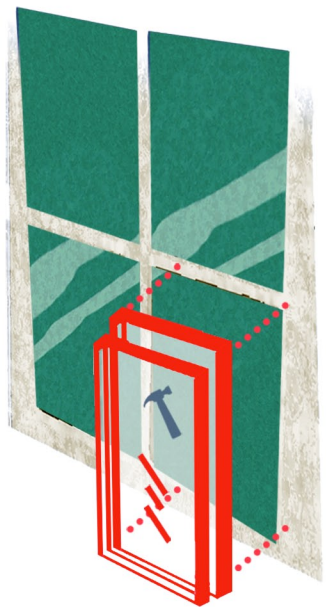
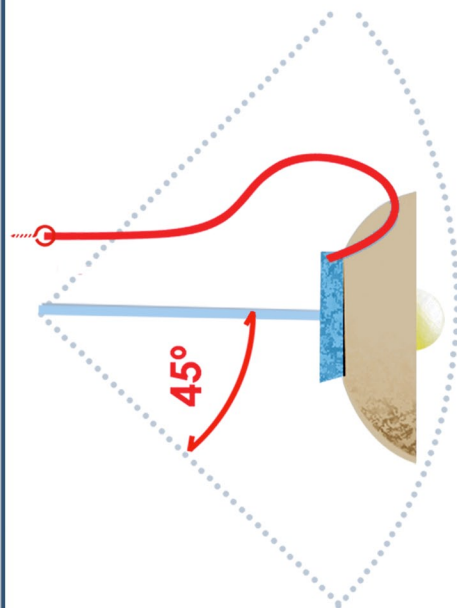
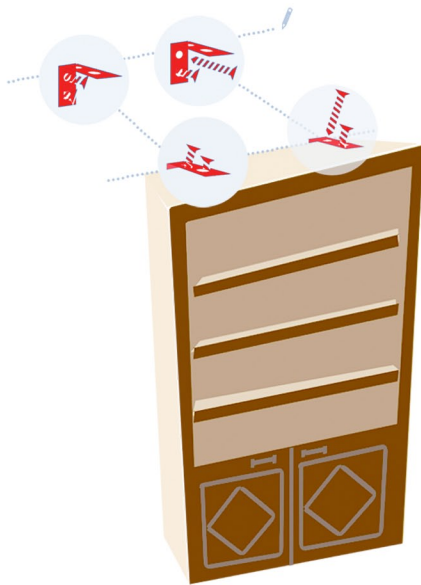
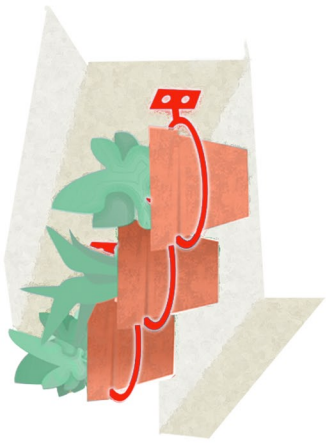

**Fai la
cosa
giusta!**



**Fai la
cosa
giusta!**



**Fai la
cosa
giusta!**



**Fai la
cosa
giusta!**



**Fai la
cosa
giusta!**



**Fai la
cosa
giusta!**



**Fai la
cosa
giusta!**



**Fai la
cosa
giusta!**



**Fai la
cosa
giusta!**



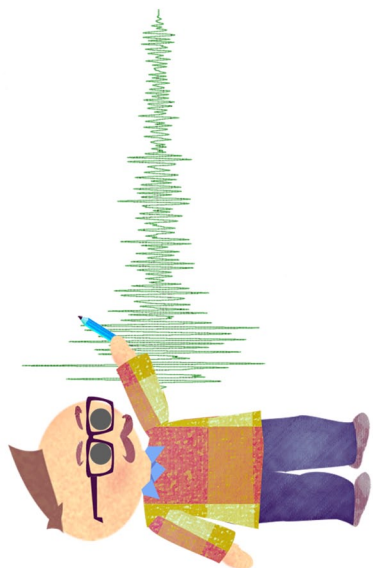
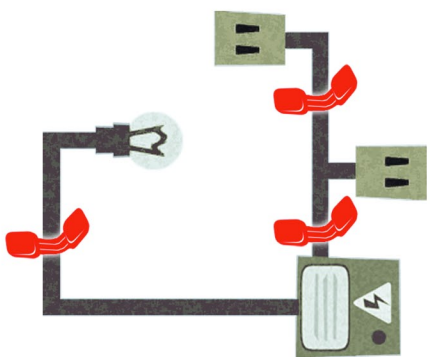
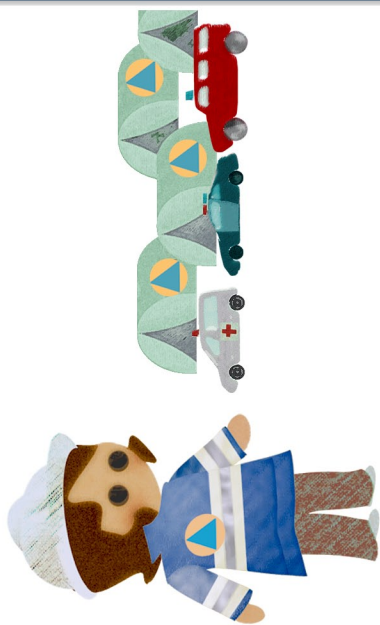

**Fai la
cosa
giusta!**



**Fai la
cosa
giusta!**



**Fai la
cosa
giusta!**



**Fai la
cosa
giusta!**



**Fai la
cosa
giusta!**



**Fai la
cosa
giusta!**



**Fai la
cosa
giusta!**



**Fai la
cosa
giusta!**



**Fai la
cosa
giusta!**





**Fai la
cosa
giusta!**



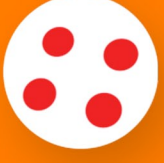

**Fai la
cosa
giusta!**



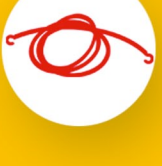
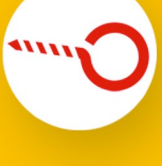
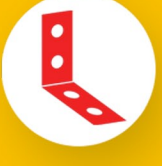

**Fai la
cosa
giusta!**





**Fai la
cosa
giusta!**



Mappa di pericolosità sismica del territorio Italiano

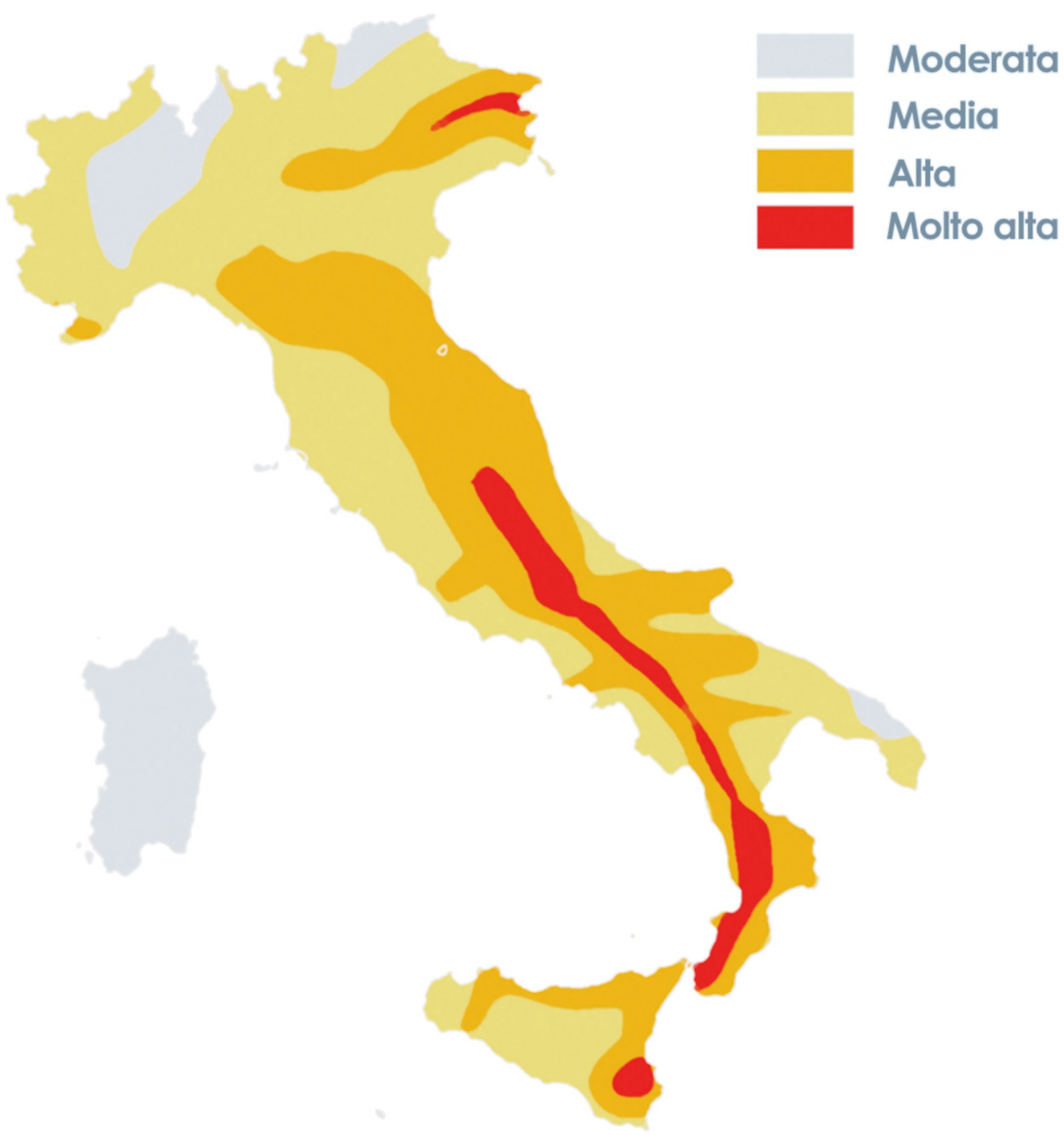

Fonte: INGV - zonesismiche.mi.ingv.it

**Fai la
cosa
giusta!**

